

A10

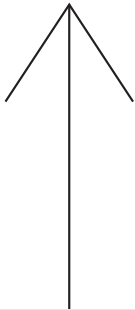

ທາງດ້ານລຸ່ມ

ທາງດ້ານຂວາ

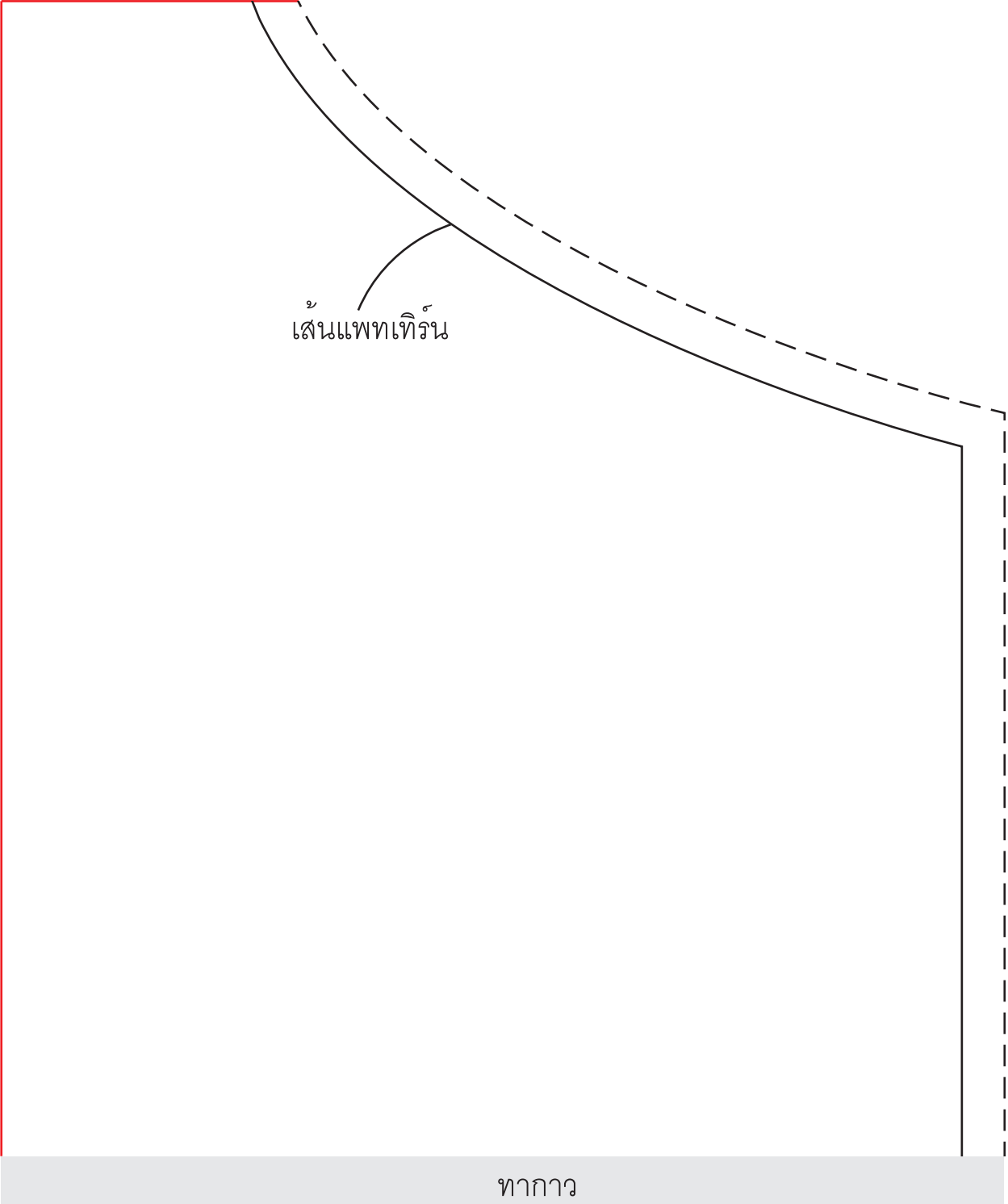

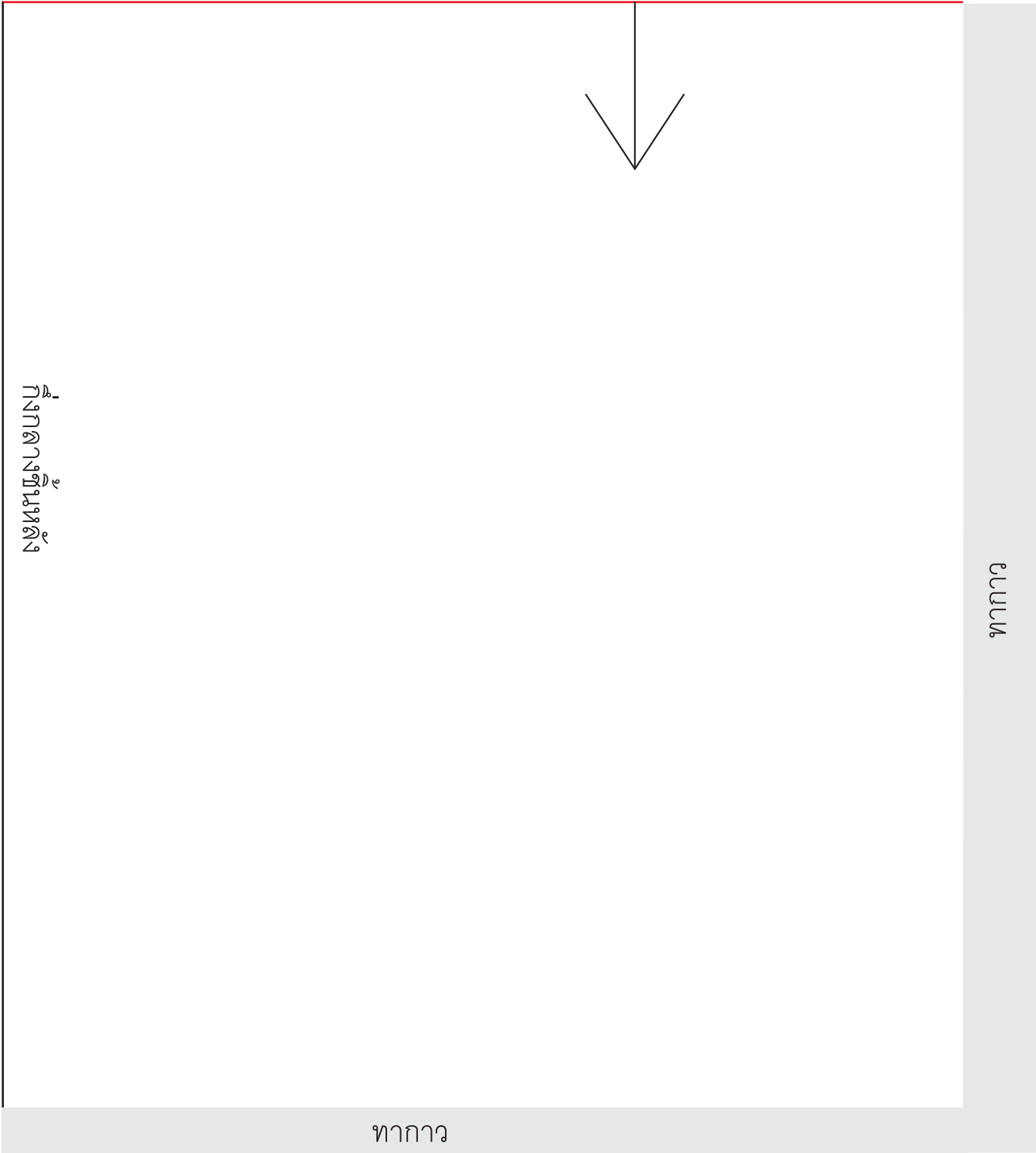

A10

ข้างลำตัว

தாகาว

A10

พิกาว

พิกาว

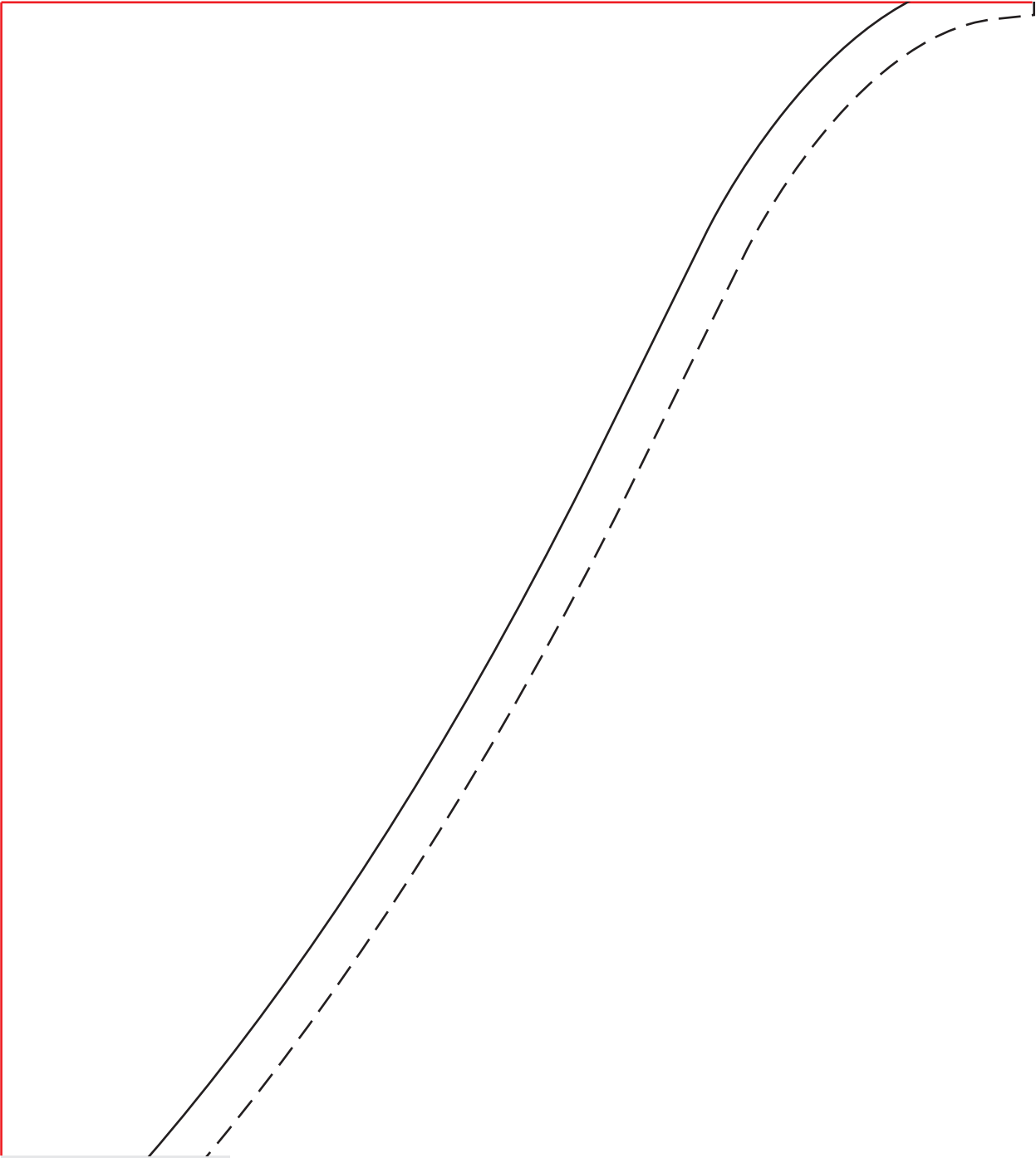

தாகர்

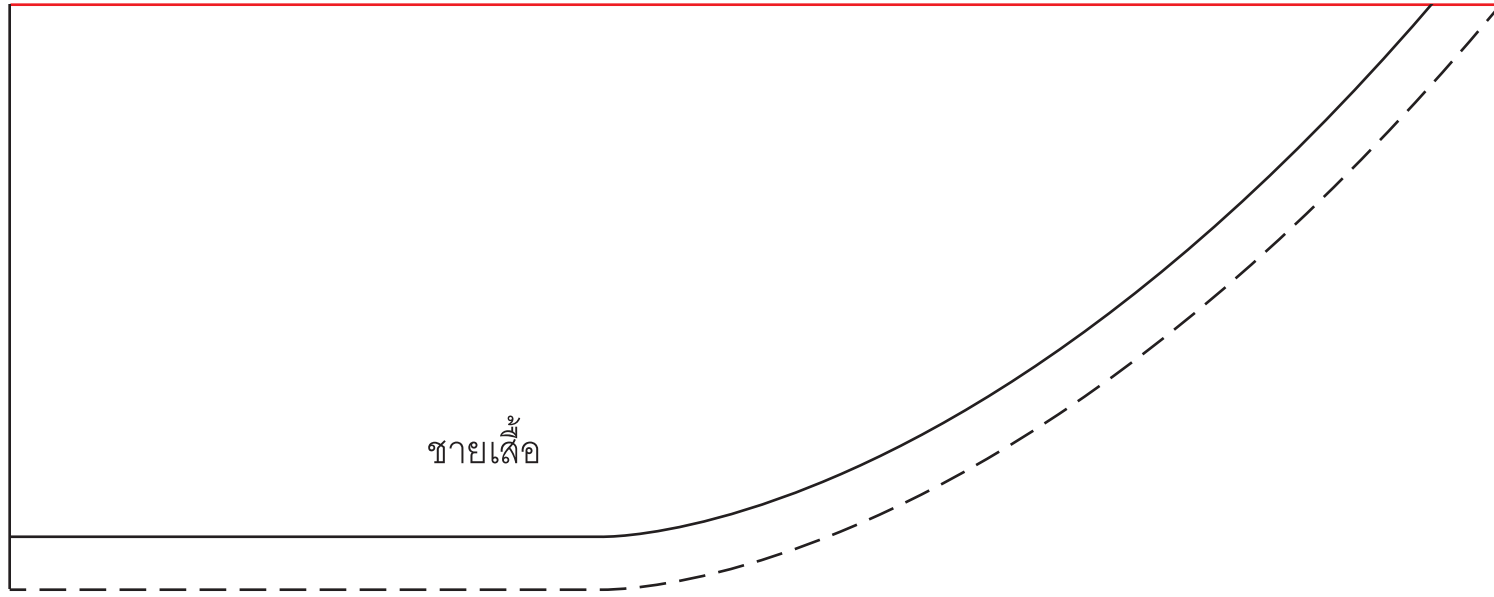

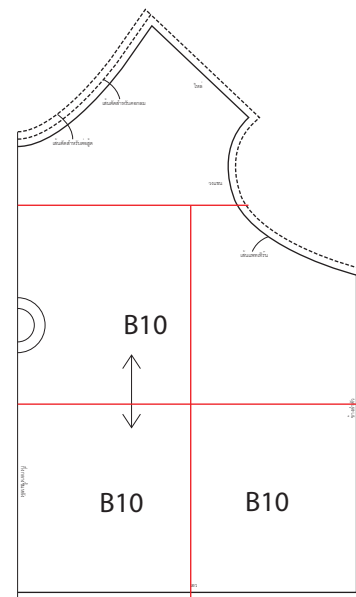
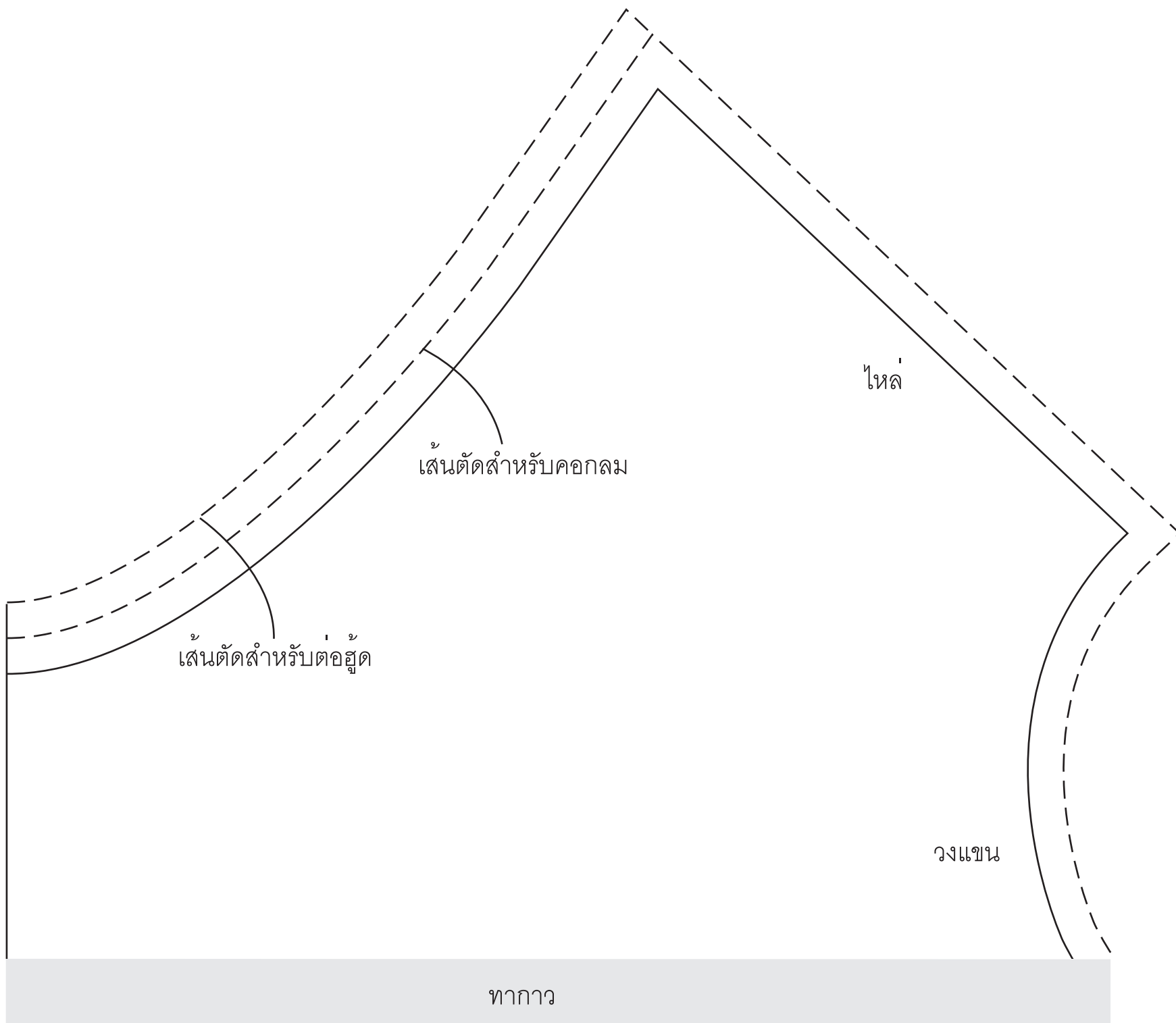

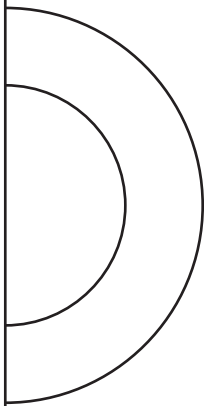

B10

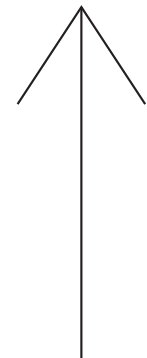

தாக

தாக

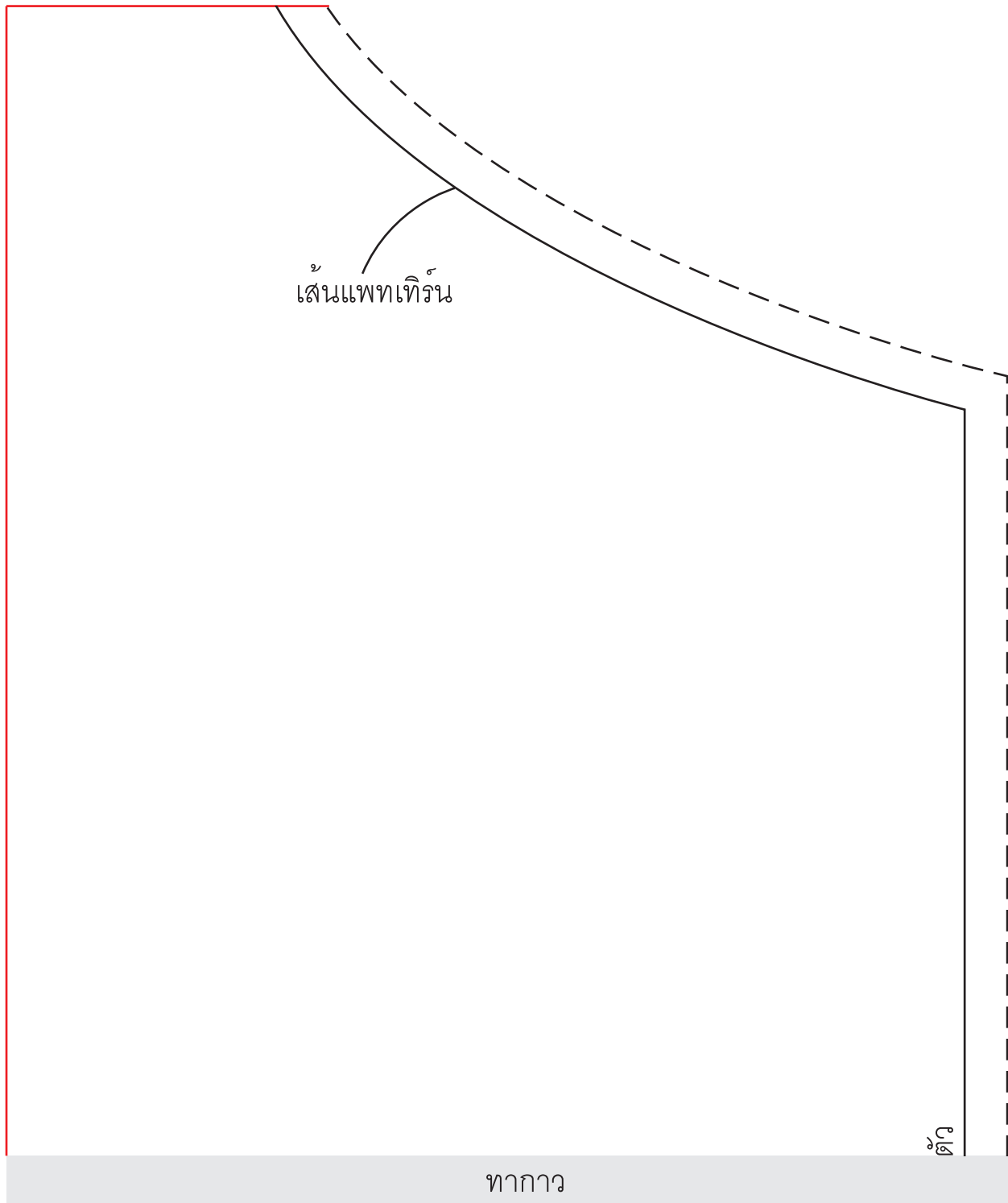

เลขที่หนังสือแนบ

B10

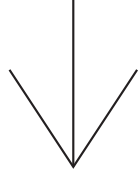

พิกัด

B10

๒
หน้า

๒๖

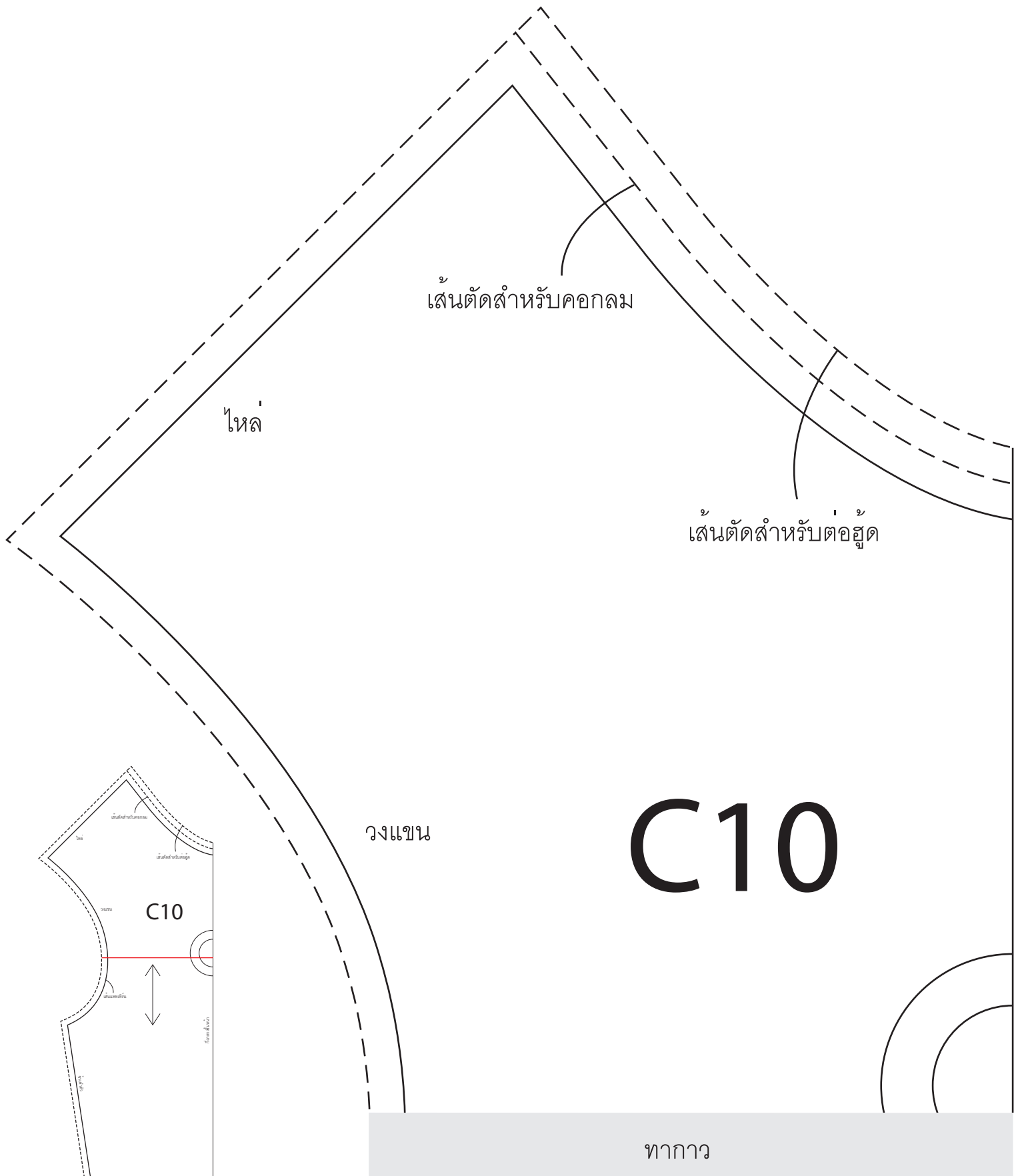

เส้นตัดสำหรับคอกกลม

ไหล่

เส้นตัดสำหรับต่อฮูด

วงแขน

C10

தாகาว

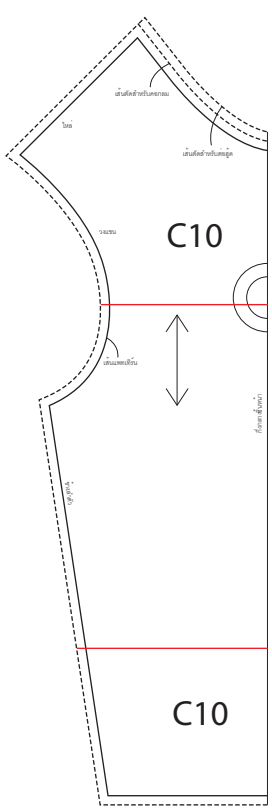

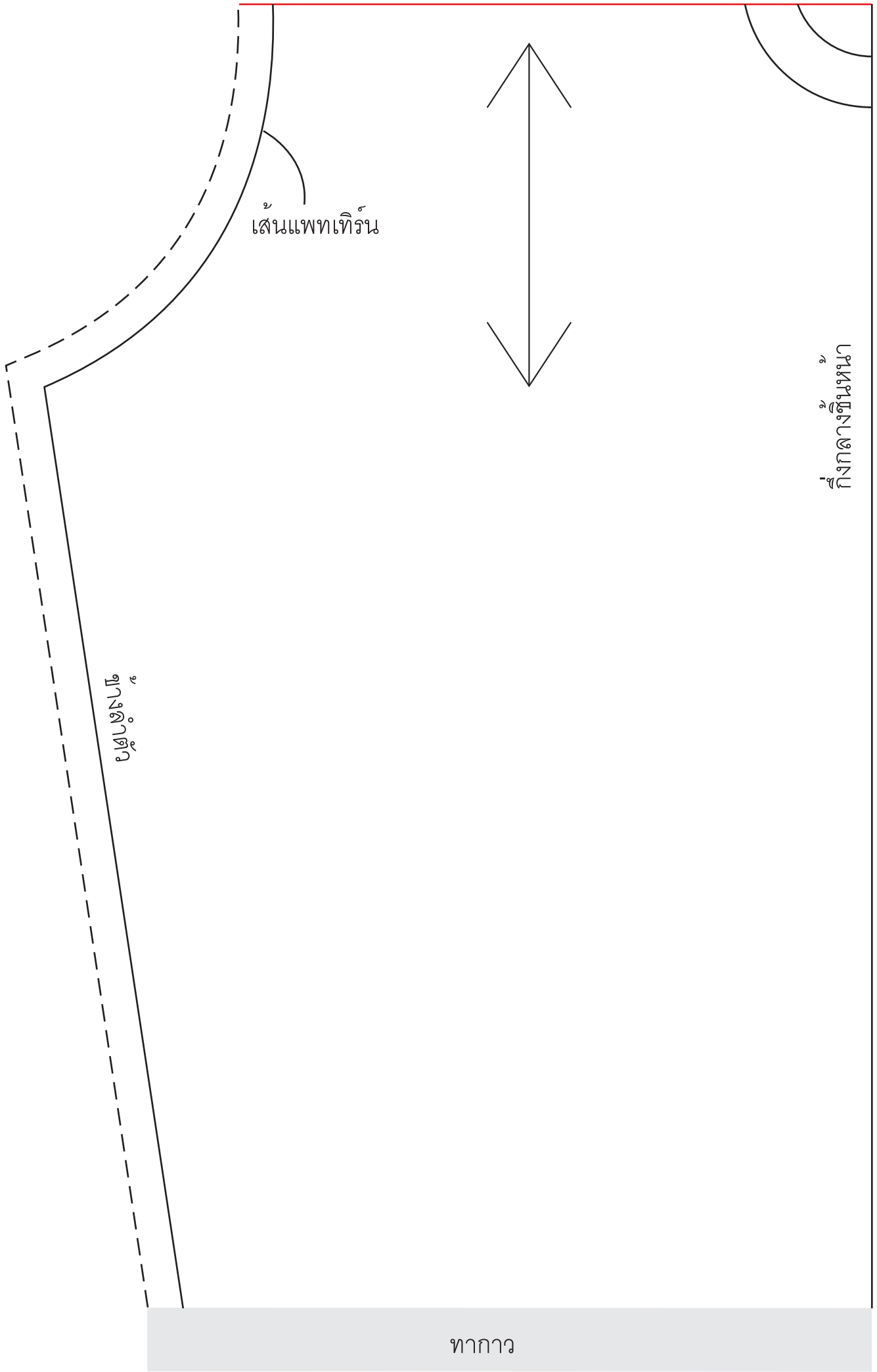

เส้นแพทเทิร์น

บัญชีเลข๒๕

กึ่งกลางชิ้นหนา

ทากาว



C10

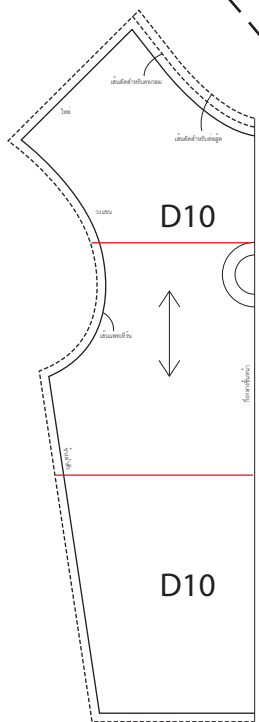
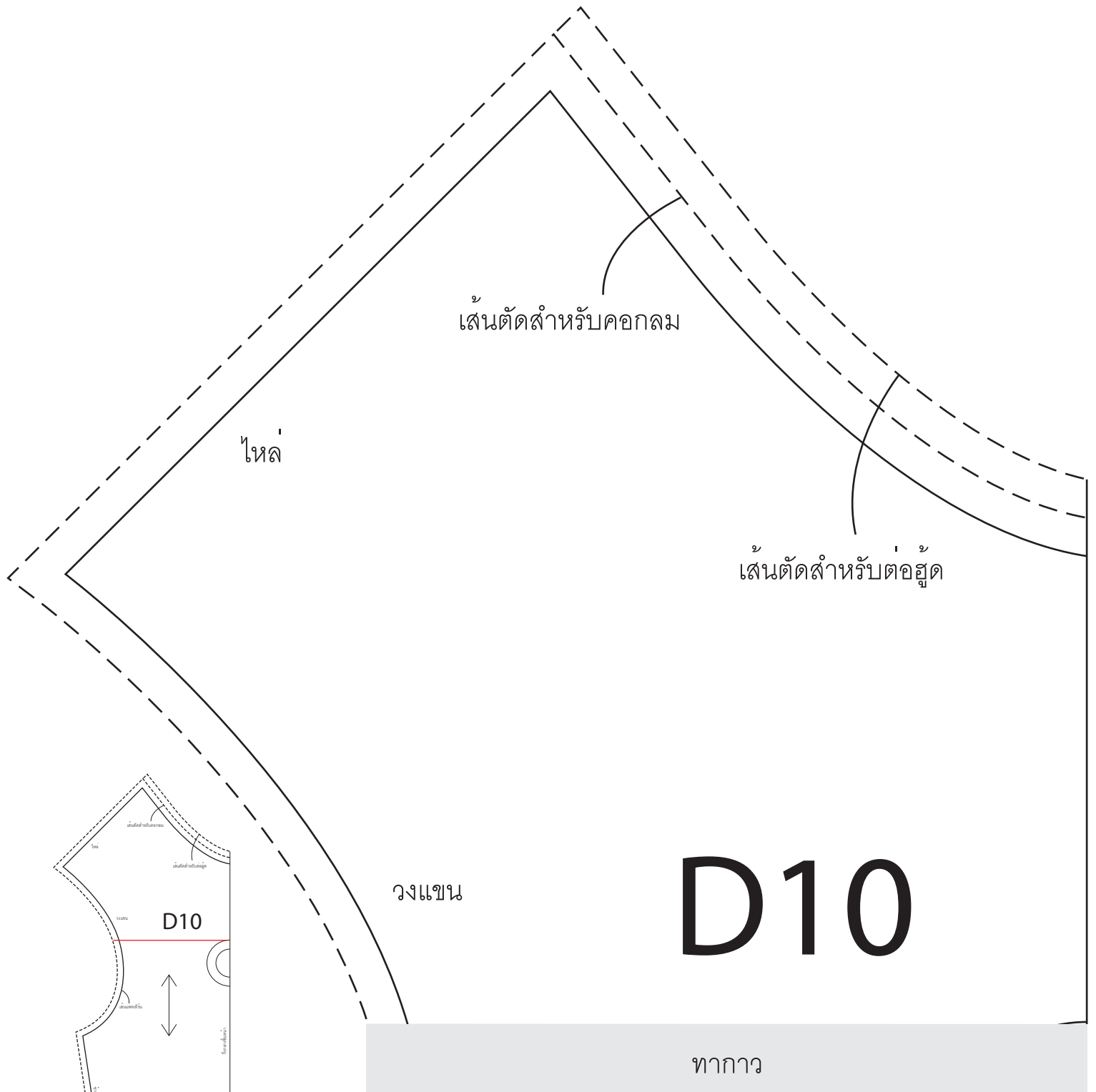

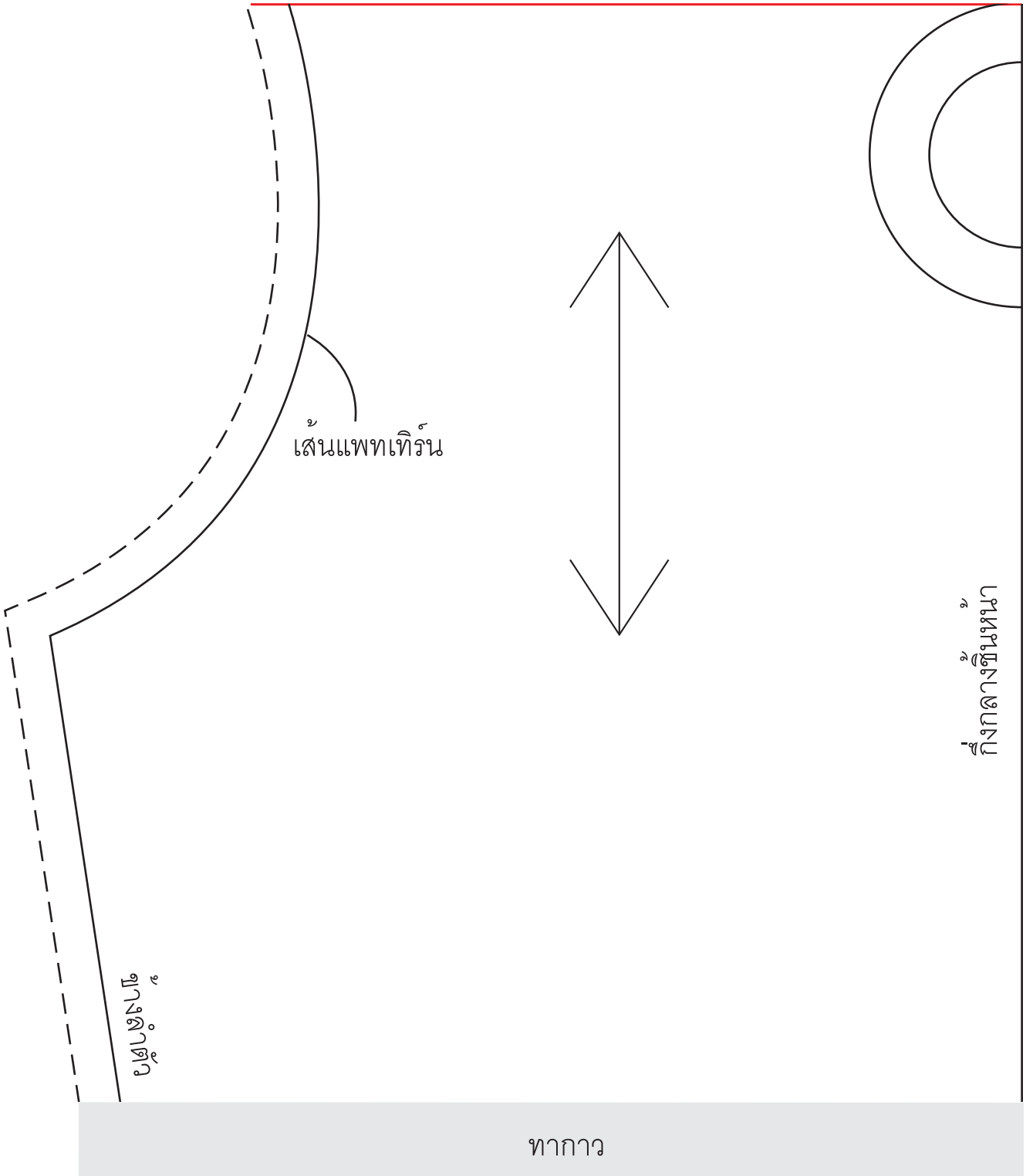



D10

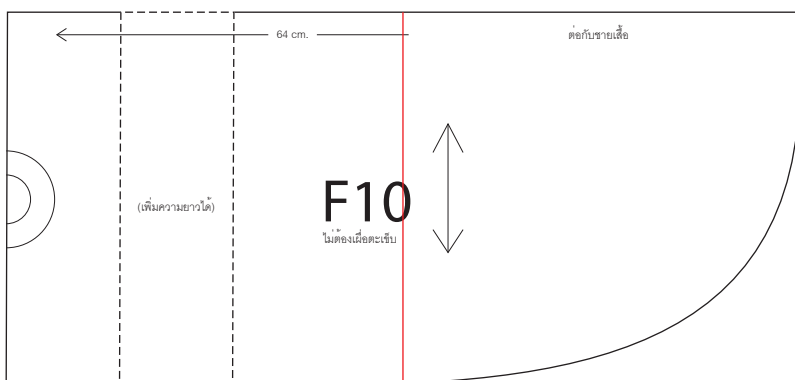
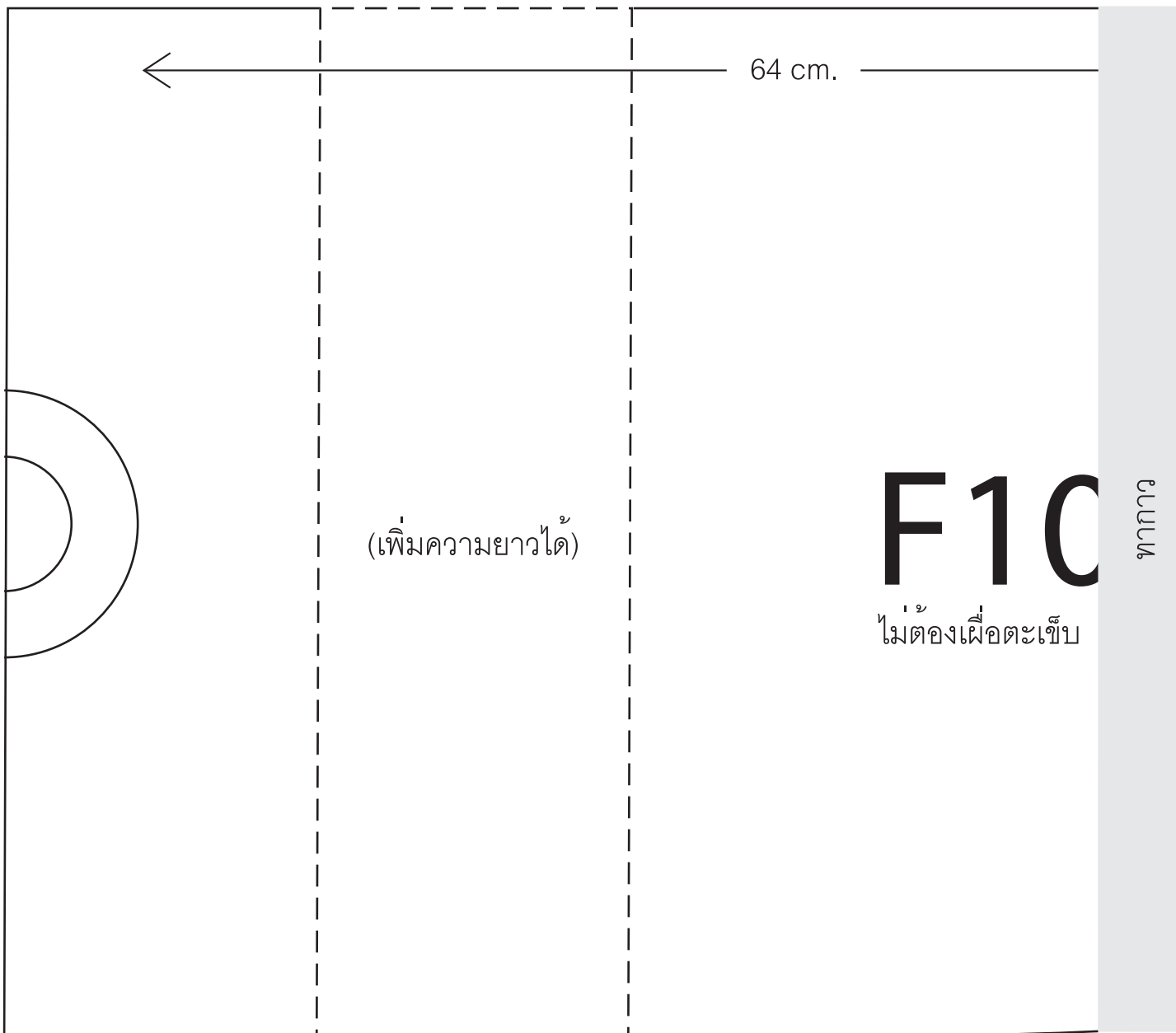

ต่อกับชายเส้น

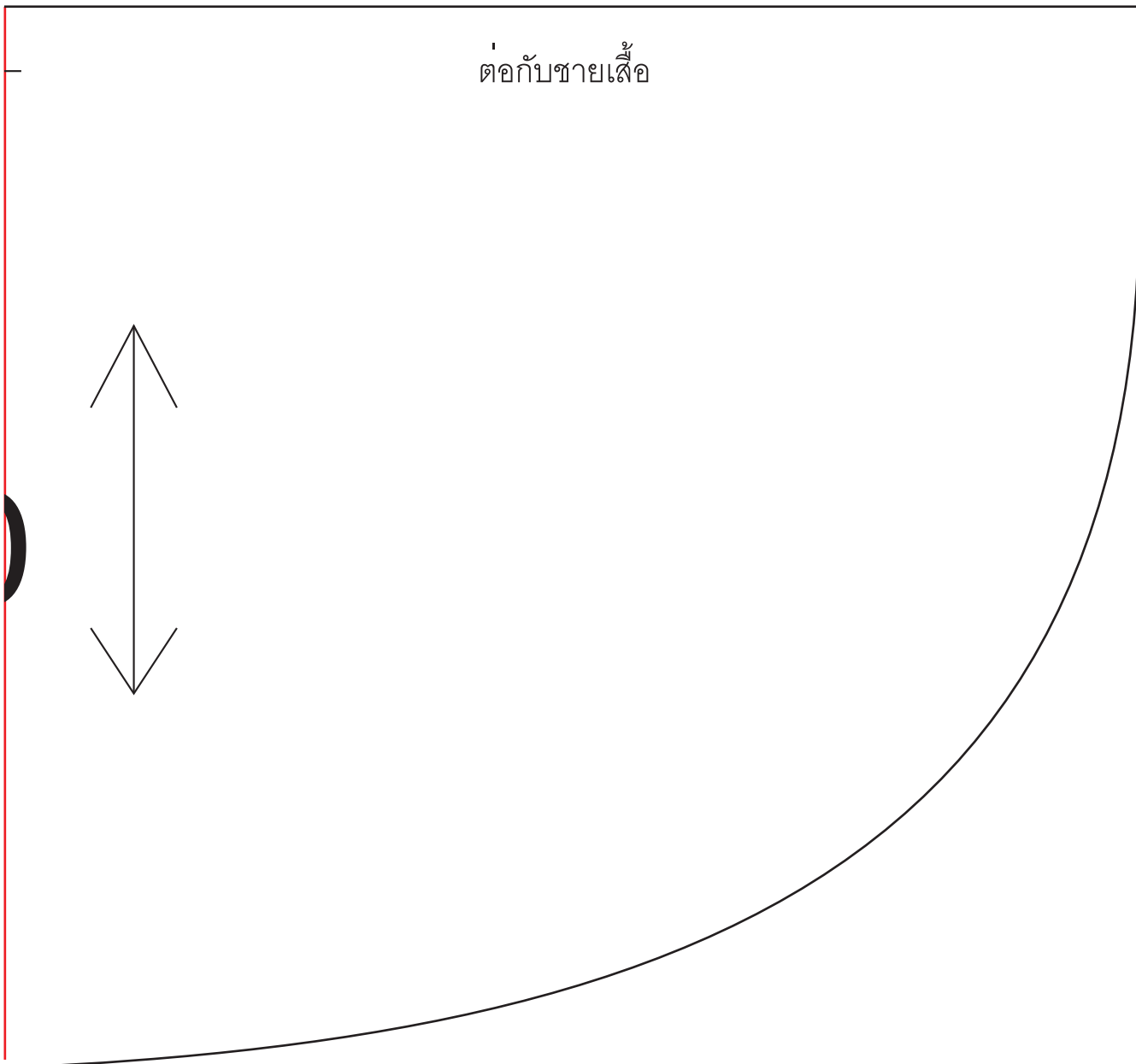



64 cm.

(เพิ่มความยาวได้)

G1

ไม่ต้องเผื่อตะเข้

தாகาว

ต่อกับชายเสื้อ

0

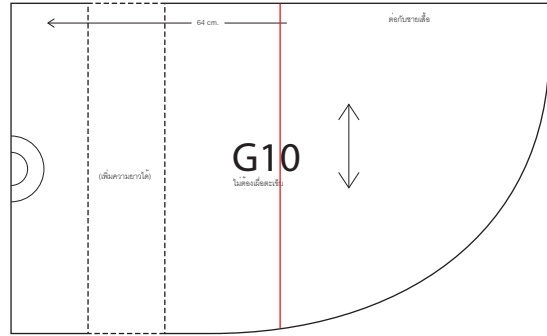



64 cm.

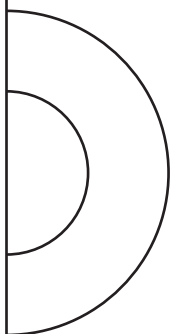

(เพิ่มความยาวได้)

H1

ไม่ต้องเผื่อตะแคง

พิกาว

ต่อกับชายเสื้อ

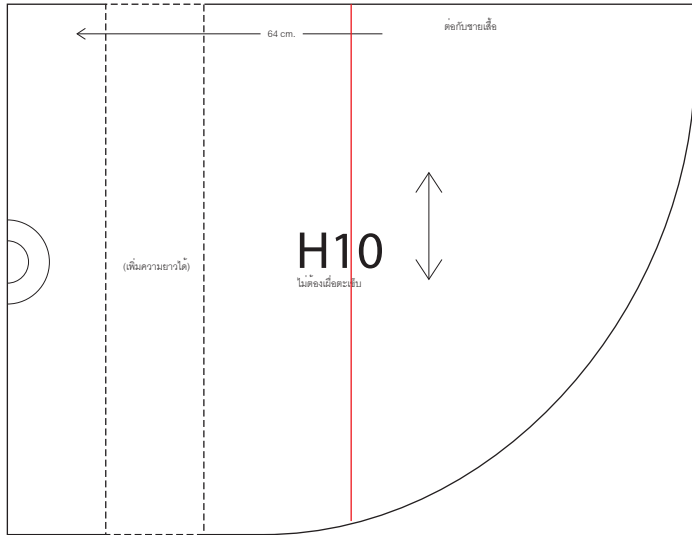

0

รูป

I10

தாகარ



தாகარ

I10

தாகარ

சு
கி

I10

ต่อกับคอเสื้อ

สิ่งกีดขวาง

I10

