

A6(dress)

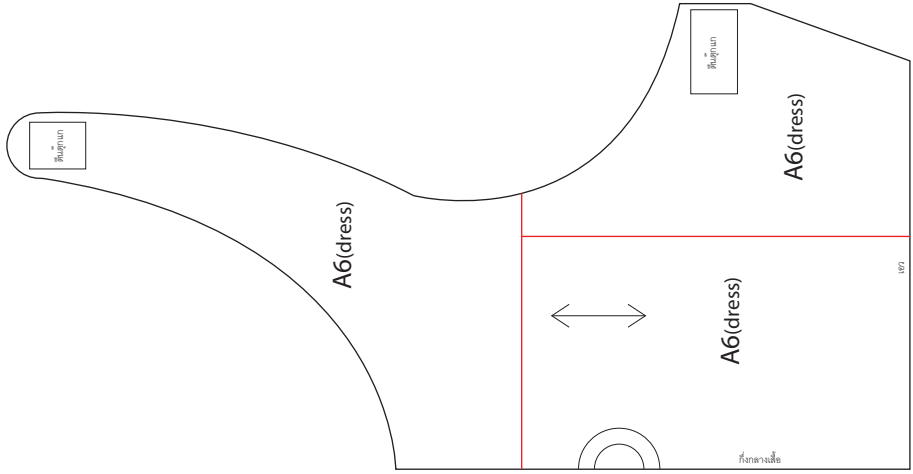

தாகავ

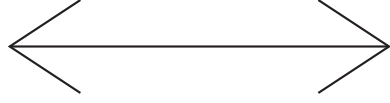

A6(address)

ცხვი

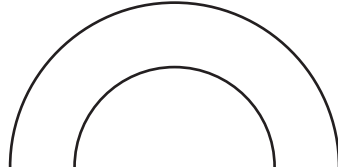

კიგკლგსეი

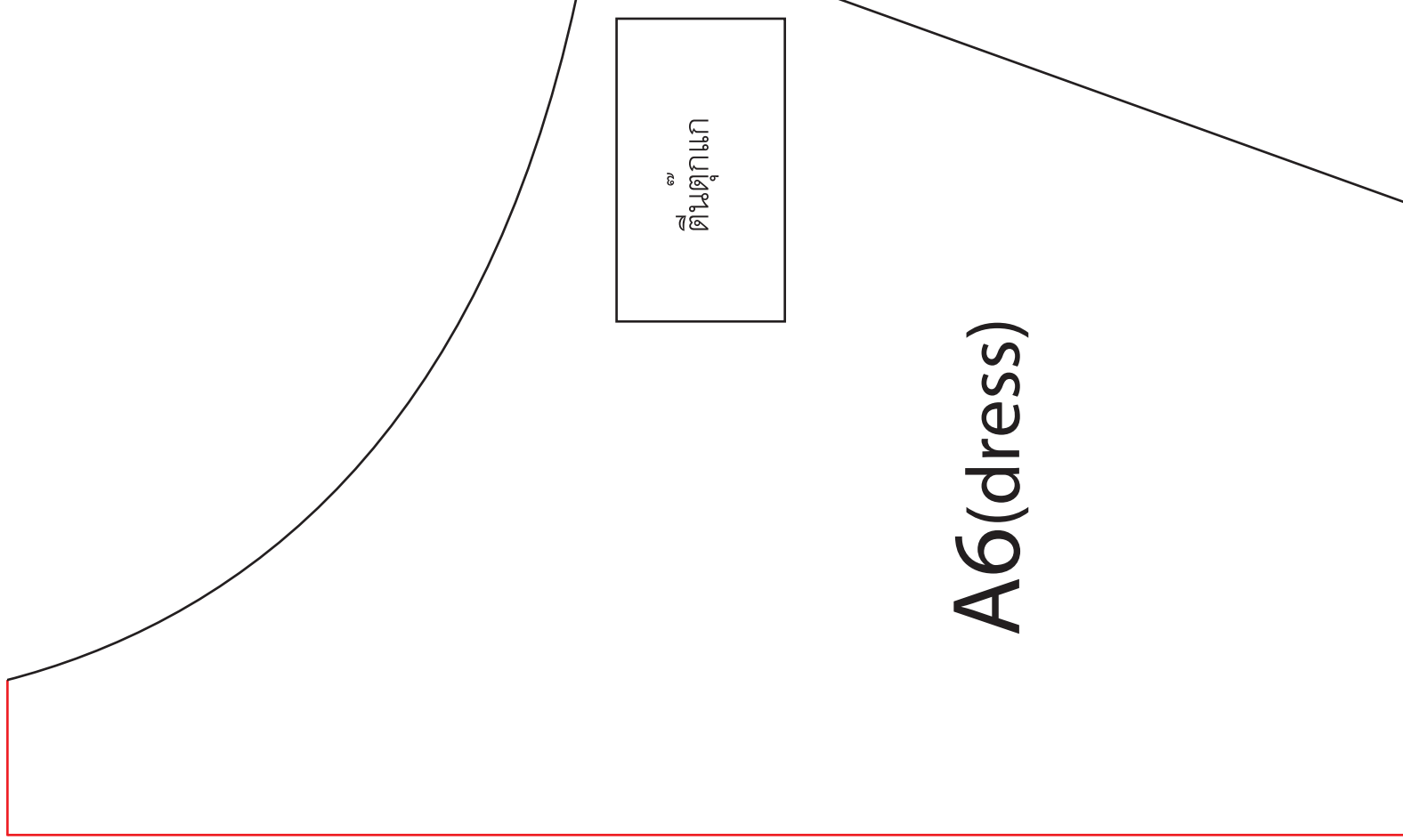

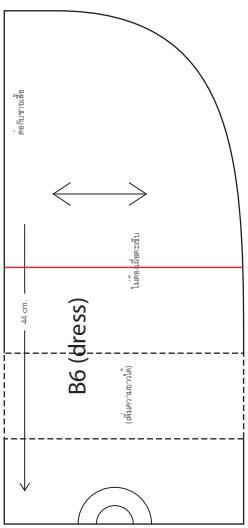
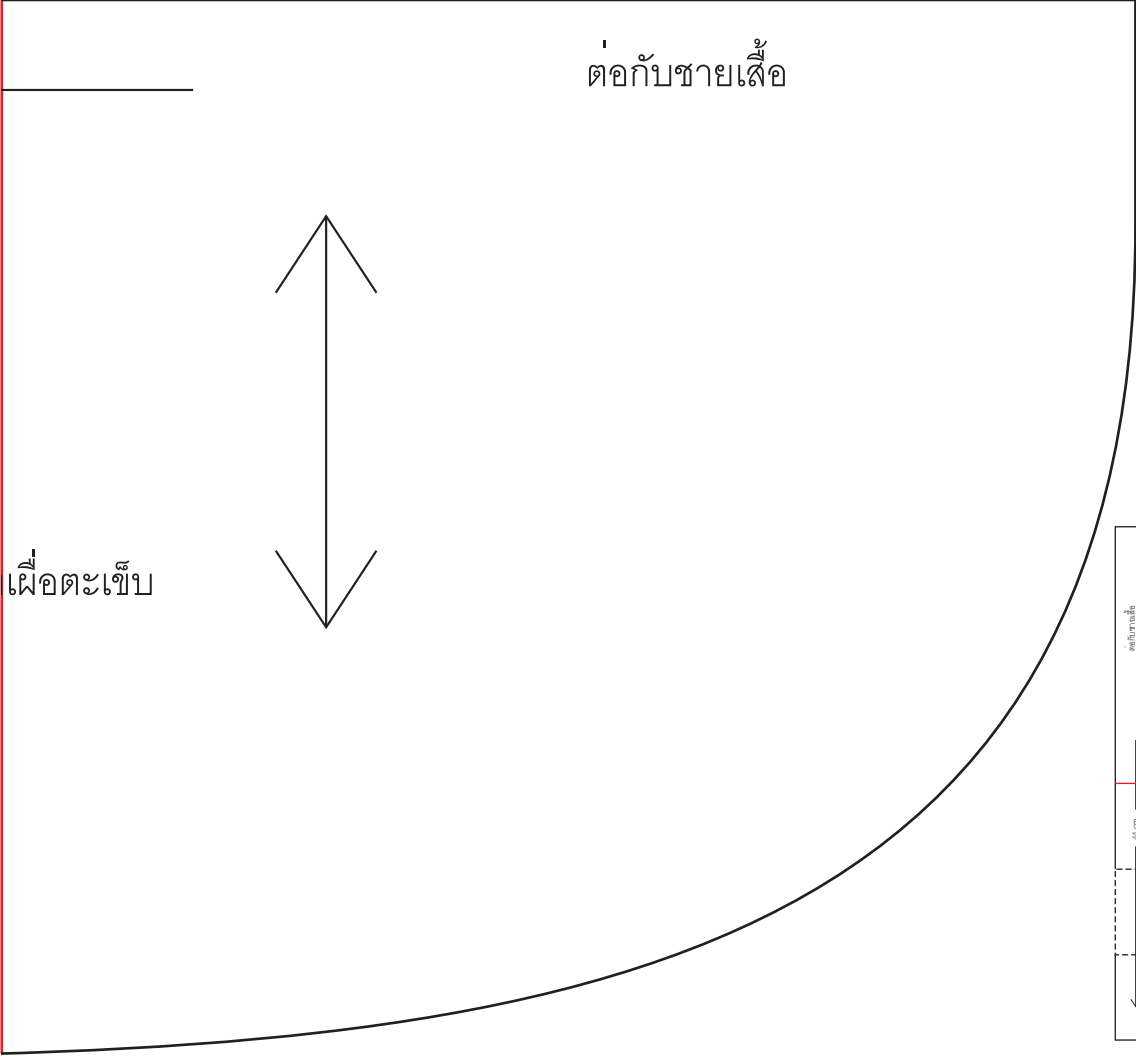
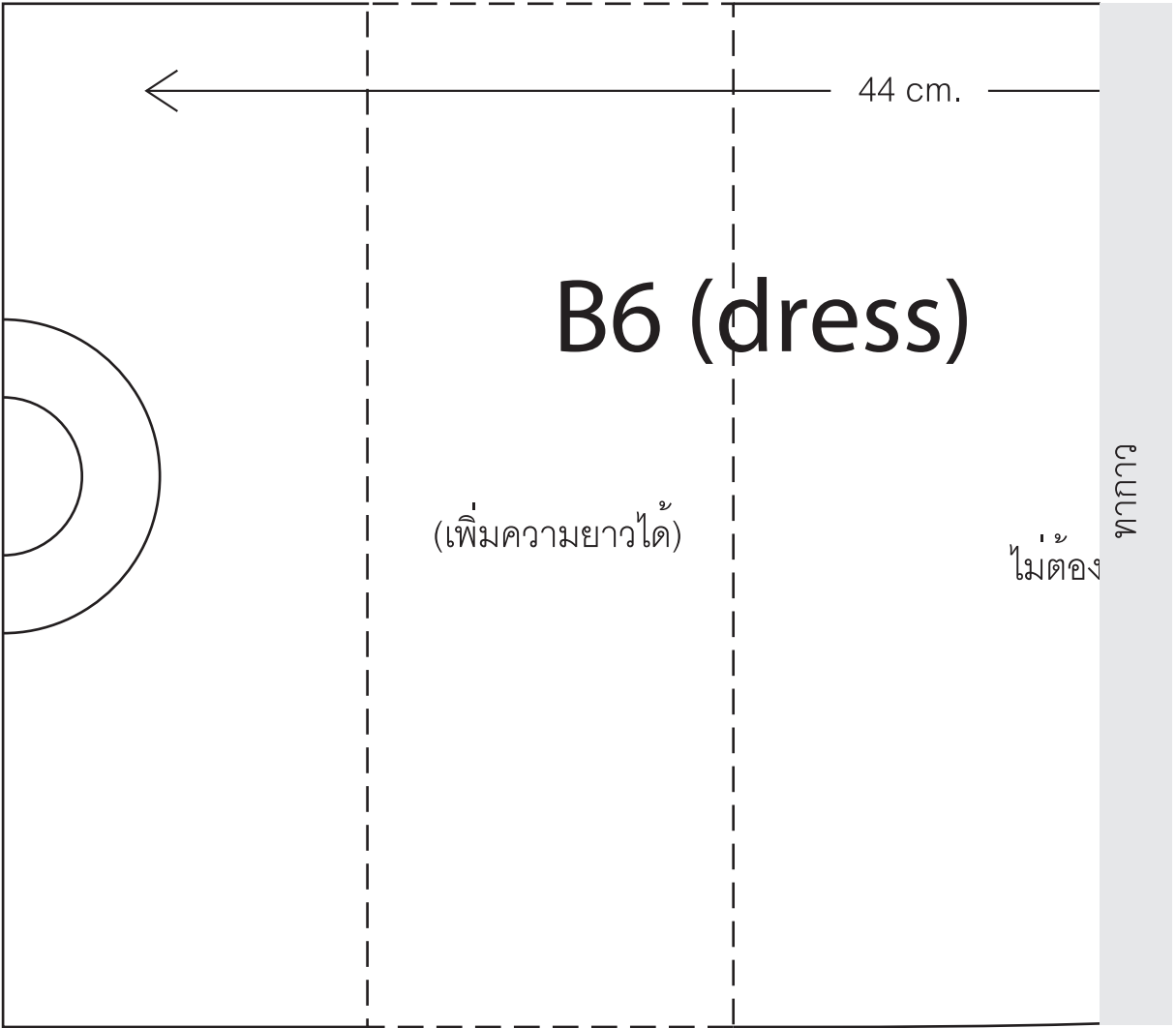

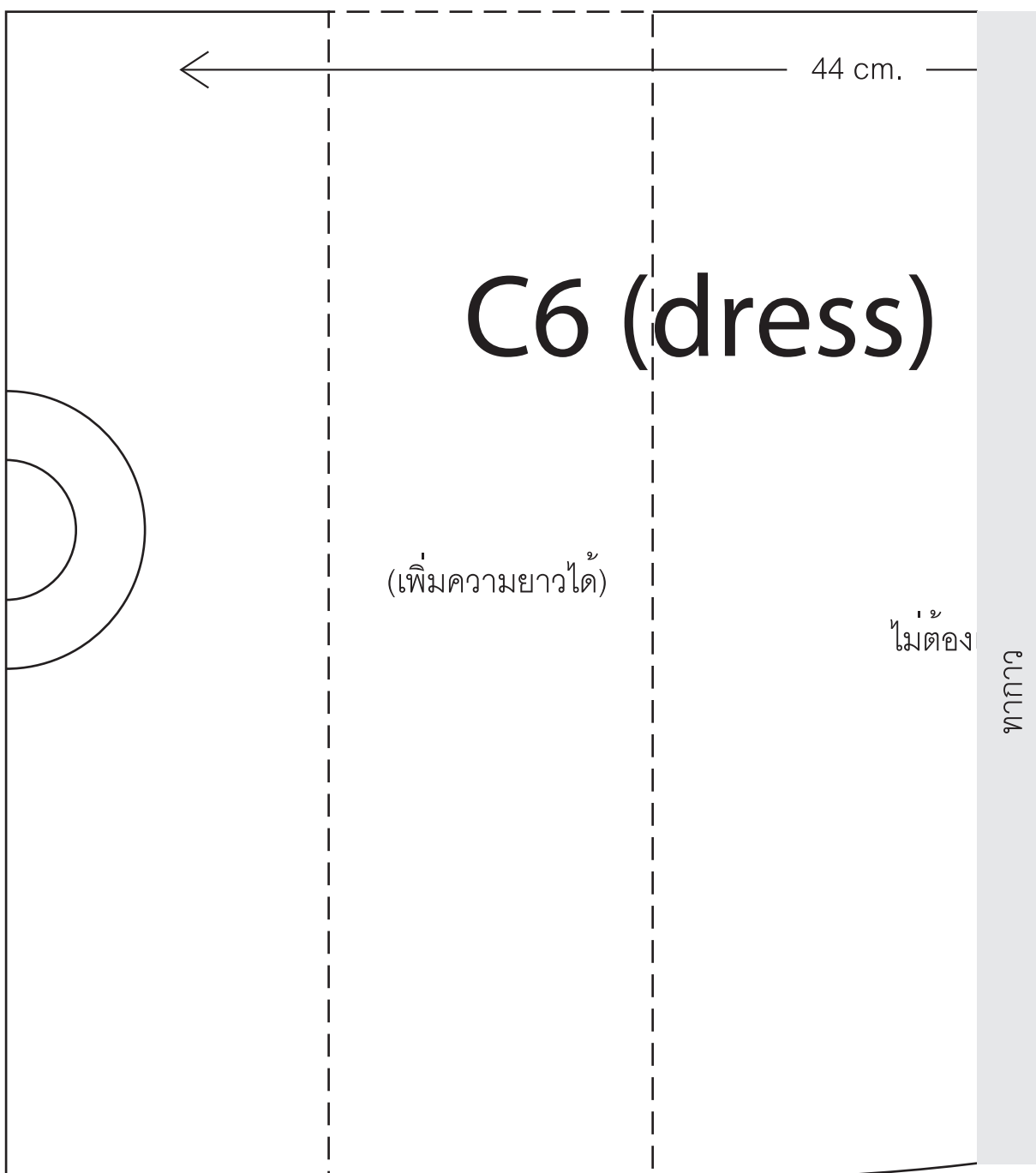
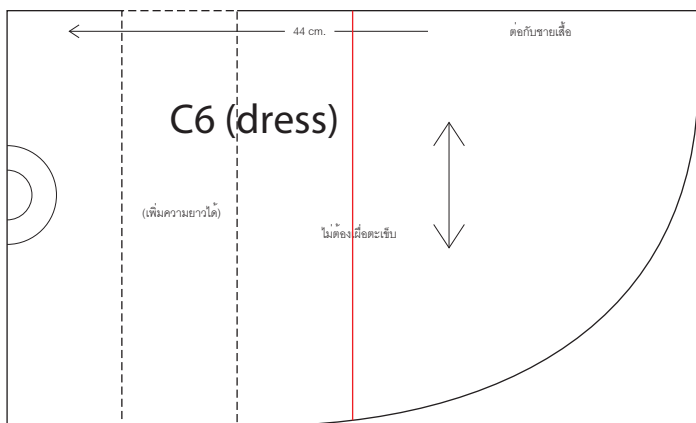

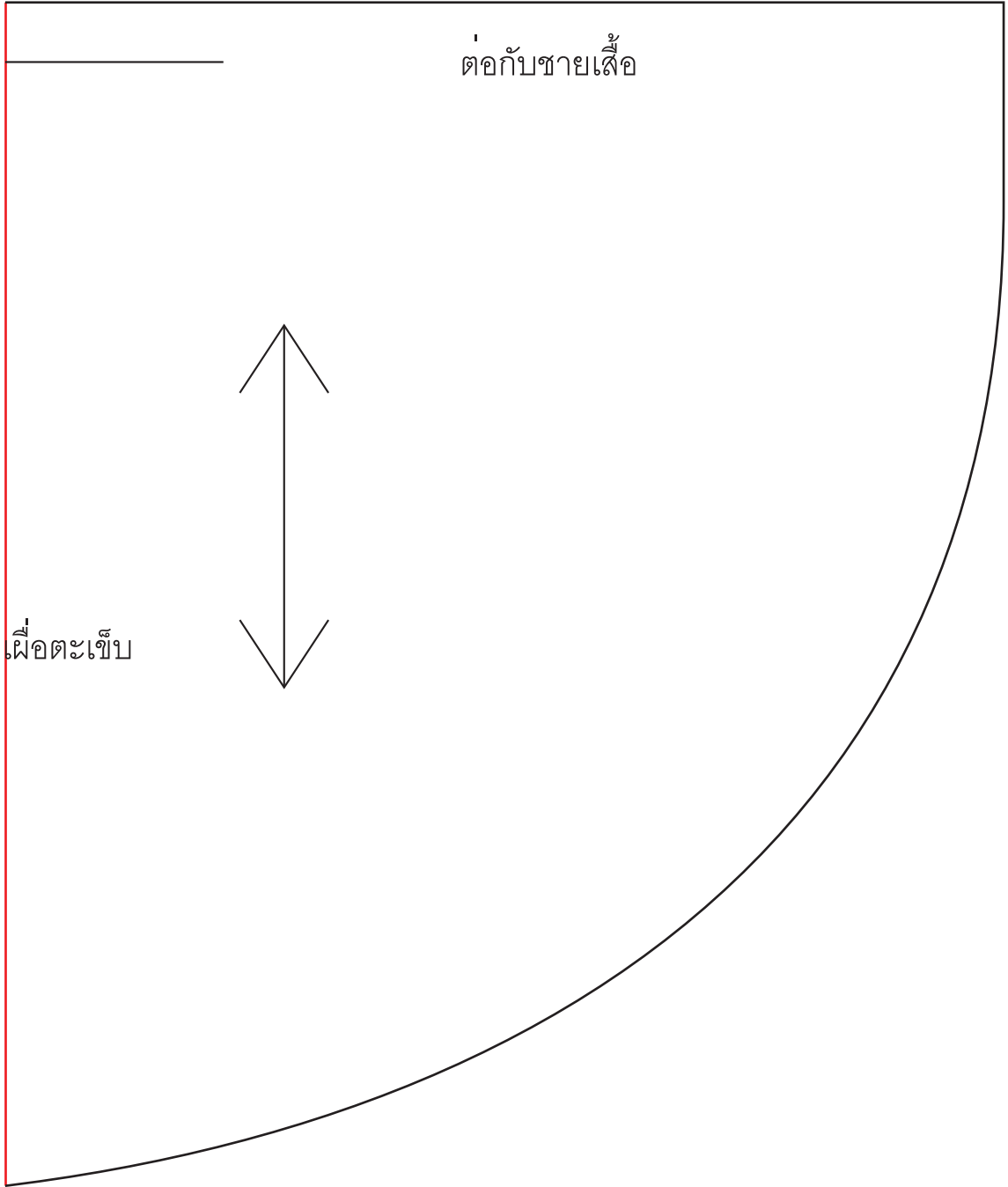

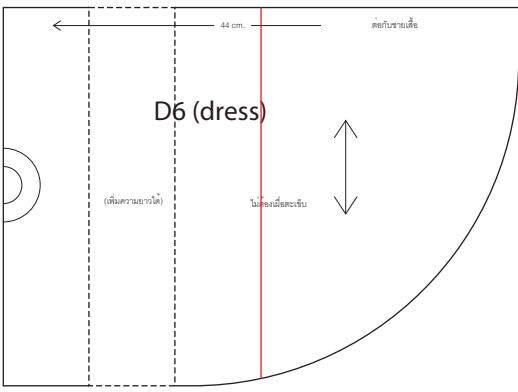

ต่อกับชายเส้น



คลองผดุงประหาร



